

**gio** *power sport*  
Adventure Starts

**Blazer 125**  
**Mini Blazer 110/Blazer 110**  
**Blazer 125U**

WARNING: READ THIS MANUAL CAREFULLY!



**Imported by / Importé par:**  
GVA Brands Corporation  
Unit 1 - 11440 Twigg Place  
Richmond, BC V6V 3C1  
[www.gvabrands.com](http://www.gvabrands.com)

**MADE IN CHINA / FABRIQUÉ EN CHINE**

## INTRODUCTION

Thank you for your purchase GIO ATV.

This manual will provide you with a good basic understanding of the features and operation of this ATV.

This manual includes important safety information. It provides information about special techniques and skills necessary to ride your ATV. It also includes basic maintenance and inspection procedures.

Please be close reading this manual, it will maximize the performance and lifetime of ATV.

## IMPORTANT MANUAL INFORMATION

**FAILURE TO FOLLOW THE WARNINGS AND CONTAINED IN THIS MANUAL CAN RESULT IN SERIOUS INJURY OR DEATH.**

The safety alert symbol means attention!



Failure to follow warning instructions could result in severe injury or death to the machine operator, a bystander or others who inspection or repairing the machine.

**CAUTION:** A caution shows special precautions that must be taken to avoid damage to the machine.

All Terrain Vehicle Safe Riding.....	02	Inspection And Maintenance.....	22
Important Notice To Parents.....	02	Maintenance Schedule.....	22
Safe Riding Rules.....	03	Periodic Maintenance Chart.....	23
Protective Clothing.....	03	Seat Removal.....	24
Refitting.....	03	Air Cleaner.....	24
Loading.....	03	Spark Plug.....	24
Accessories.....	04	Idle Speed Adjustment.....	25
Serial Number Location.....	04	Throttle Cable Adjustment.....	26
Fuel And Oil Recommendations.....	05	Fuel Hose.....	26
Location Of Parts.....	05~08	Engine Oil.....	26
Controls.....	09	Brake.....	26
Left Handlebar.....	09	Recoil Starter Engagement Adustment.....	27
Choke Lever.....	10	Tires.....	28
Equipment And Adjustments.....	11	Tire Pressure.....	28
Remote Engine Stop Switch.....	12	Tire Replacement.....	28
Break-In.....	13	Tubeless Tire Repair.....	29
Maximum Throttle Opening Reccomendation.....	13	Drivechain.....	29
Very The Engine Speed.....	13	Drive Chain Cleaning And Oiling.....	29
Avoid Constant Low Speed.....	13	Front And Rear Wheel Removal.....	30
Observe Your Initial And Most Critical Service.....	13	General Lubrication.....	30
Inspection Before Riding.....	13	Troubleshooting.....	31
Riding Tips.....	14	Fuel System Check.....	31
Starting The Engine.....	14	Ignition System Check.....	31
Starting Off.....	15	Transportation.....	32
Braking.....	15	Starting After Transport.....	32
Turning.....	16	Cleaning Procedure.....	32
Turning At Higher Speeds.....	16	Preparation For Cleaning.....	33
Skidding Or Sliding.....	16	Washing Your ATV.....	33
Opertion On Hills.....	17	Inspection After Cleaning.....	33
Riding Through Water.....	18	Storage Procedure.....	34
Stopping The Engine.....	19	Vehicle.....	34
Parking The Vehicle.....	19	Fuel.....	34
Instructing The Young Rider.....	19	Engine.....	34
Proper Clothing And Protective Gear.....	19	Tires.....	34
Familiarization With The Vehicle.....	20	External.....	34
Starting Off And Stopping.....	20	Procedure For Returning To Service.....	35
Turning.....	21	Circuit Diagram.....	35
Putting It All Together.....	21	Specification.....	36~37

## PREFACE

This manual describes the basic operation and maintenance for the All Terrain Vehicle, which should be read carefully before operation. Proper operation and maintenance will minimize problems with the All Terrain Vehicle and keep it in optimal performance. Your dealer will provide you with technical and after sales service.

## IMPORTANT NOTICE

### Operator and passenger

This All terrain vehicle is designed to carry only the operator. Never exceed the maximum weight capacity as specified in the manual.

### Off-Road use

This All Terrain Vehicle is designed to be used for off-road use only. Do not ride on public road

### WARNING

Indicates a strong possibility of severe personal injury or death if instructions are not followed.

#### Caution:

Indicates a possibility of personal injury or equipment damage if instructions are not followed

Note: Gives helpful information.

This manual should be considered as a permanent part of the All Terrain Vehicle and should remain with the All Terrain Vehicle when resold.

### WARNING

## ALL TERRAIN VEHICLE SAFE RIDING

All Terrain Vehicle riding requires special efforts on your parts to ensure your safety. Know these requirements below before you ride.

## IMPORTANT NOTICE TO PARENTS

### WARNING

Even though the ATV has four wheels, it can tip over in any direction. Improper turning on hills can lead to vehicle to tip over. Learn proper riding techniques and avoid riding situations which can lead to tip the vehicle over.

The ATV and other all terrain vehicles (ATVs) have unique handling characteristics. ATVs' handles differently than motorcycles. Although ATVs' have four wheels, they handle differently than automobiles too. ATVs' require special riding techniques suited to their handling characteristics, so be sure that all rides of the ATV practice and master the riding techniques described in the owner's manual.

## SAFE RIDING RULES

1. No riders under the age of 16 years are permitted to ride this vehicle.
2. Both parents and their children must fully understand everything in this Owner's Manual before riding.
3. This vehicle is for OPERATOR ONLY.
4. For OFF-ROAD USE ONLY. This vehicle is designed to be operated only on level. Off-road surfaces, free of obstacles.
5. It is illegal to ride this vehicle on public roads or highways. If it is necessary to cross a public road, please get off this vehicle and push it across.
6. Do not operate this vehicle while under the influence of alcohol or drugs. This can impair judgment and result in serious injury or even death.
7. Keep safe distance between your vehicle and other off-road vehicle(s).
8. Never ride this vehicle unless it had been properly adjusted and maintained.
9. Do not allow your child to ride without supervision.
10. Never run the engine in closed area. The exhaust gas contains poisonous carbon monoxide gas(CO).
11. Don't touch any part of the engine and muffler during and even after riding, because it is very hot.
12. Do not allow to ride at night. This vehicle is not equipped with a headlight. Unseen obstacles could cause an accident resulting in injury or even death to a rider.
13. Recommends taking a safety course before riding your vehicle.

## PROTECTIVE CLOTHING

1. Protective wear such as helmet with protective mask, dustproof glasses, boots and gloves should be worn during operation for sake of personal safety. ALWAYS wear a helmet.
2. Loose clothes are not suitable for All Terrain Vehicle operation as they may get caught on the operating lever, kick lever, footrest or wheel, resulting in personal injury.
3. The exhaust system becomes hot during operation, and it remains hot for a while even after stopping the engine. Be careful not to touch the exhaust system while it is hot. Wear clothing that fully covers your legs.

## REFITTING

### WARNING

Refitting of the All Terrain Vehicle, or removal of original parts, may make the vehicle unsafe or illegal. Obey all national and local equipment regulations.

## LOADING

**Caution:** The incorrect loading could hurt the performance and reliability. Max load limit: 75KG



**ACCESSORIES**

Genuine accessories by our company have been specifically designed and tested on the all terrain vehicle. Because our company won't test accessories manufactured by other companies, you are personally responsible of selection, installation, and use of them. Always follow the guidelines below:

1. Carefully inspect the accessory to make sure that it does not obscure any lights or reflectors, reduce ground clearance, and banking angle, or limit suspension travel, steering travel or control operation.
2. Accessories may increase the time that hands or feet operate controls, resulting in decreased reaction time in an emergency.
3. Do not add electrical equipment that will exceed the vehicle's electrical system capacity
4. Do not add cooling device to the engine.

**SERIAL NUMBER LOCATION**

The frame and / or engine serial numbers are used to tile the vehicle. They are also used to assist your dealer when ordering parts or referring to special service information.

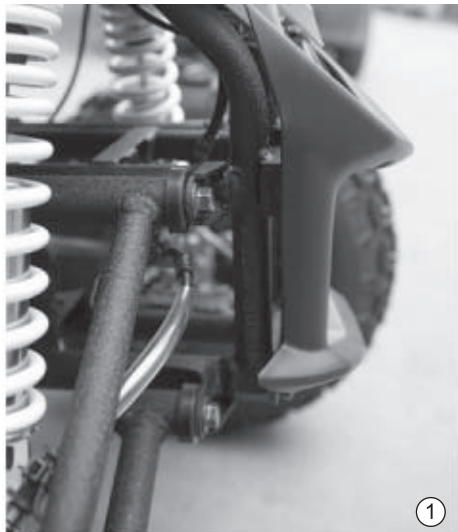

①

**THE FRAME NUMBER**

- 1.The frame number is stamped on the front frame as shown in the photograph
- 2.The engine number is stamped on the left side of the engine as picture showed

Please write down the serial number for your future reference

Frame No.:
Engine No.:

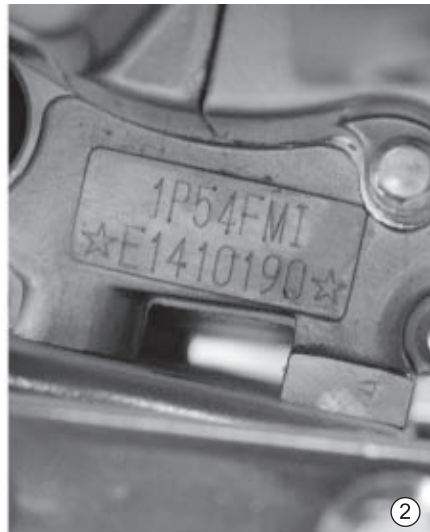

②

**Engine number**

**FUEL AND OIL RECOMMENDATIONS**

**FUEL**

Gasoline used should be graded 93 octane or higher. An unleaded type of gasoline is recommended. If engine pinging is experienced, substitute for another brand.

**Engine OIL**

Use good quality SAE 10W/40 multi grade motor oil

**LOCATION OF PARTS**

**For ATV Blazer 125**

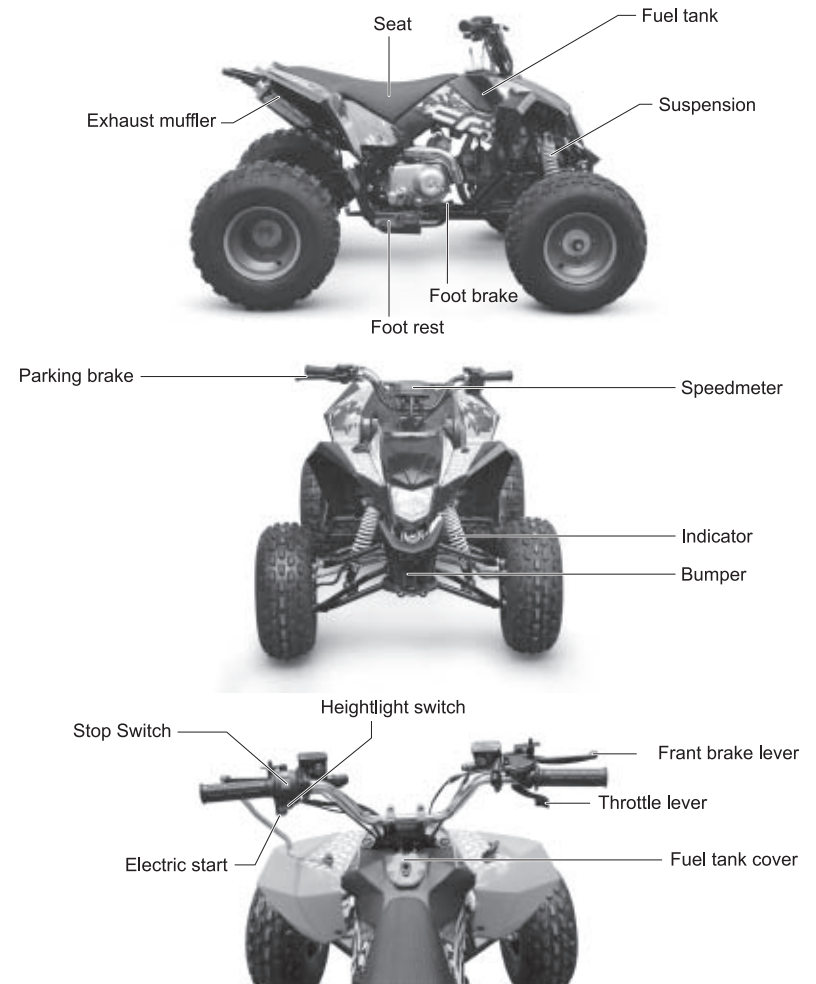

FOR Mini Blazer 110

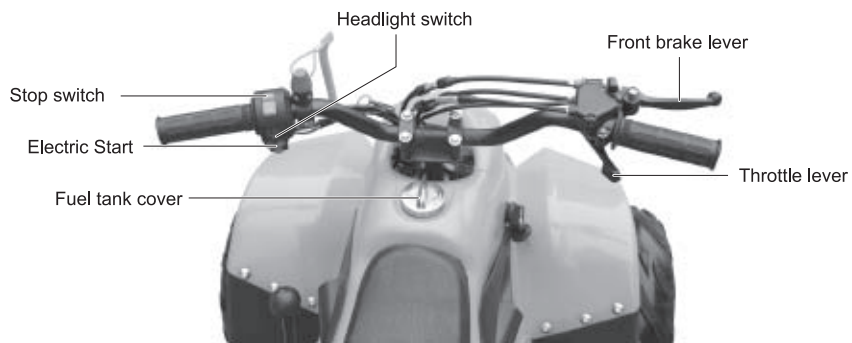
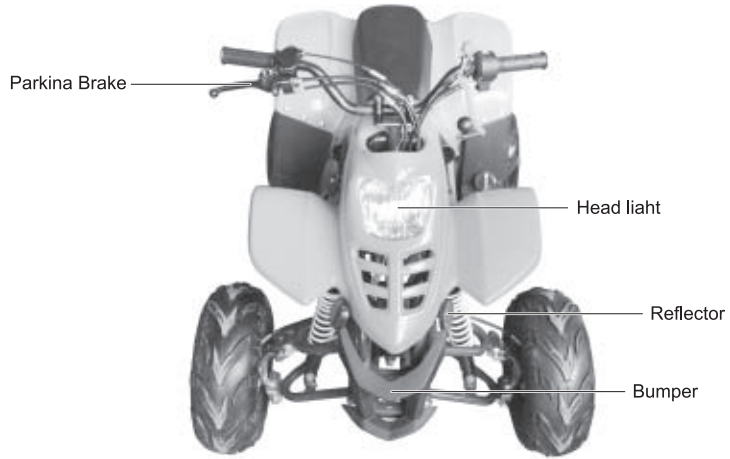
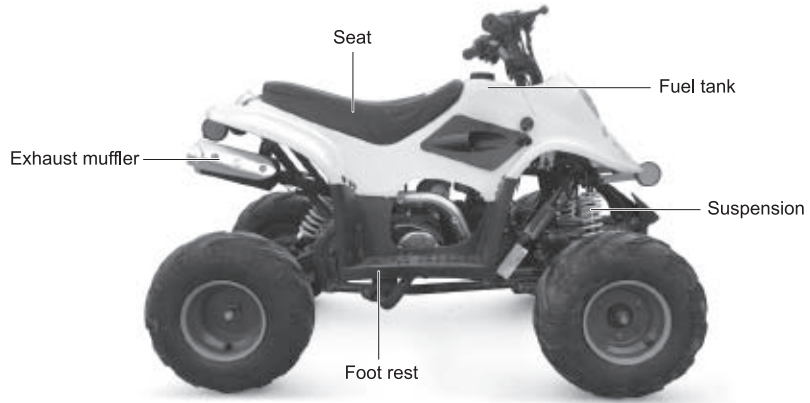

FOR Blazer 110

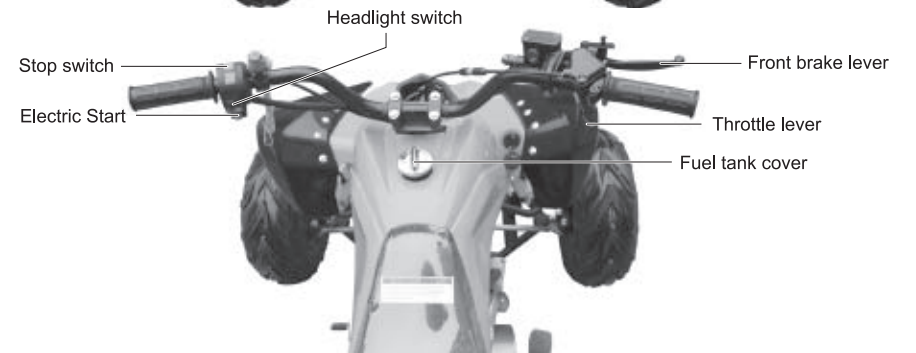
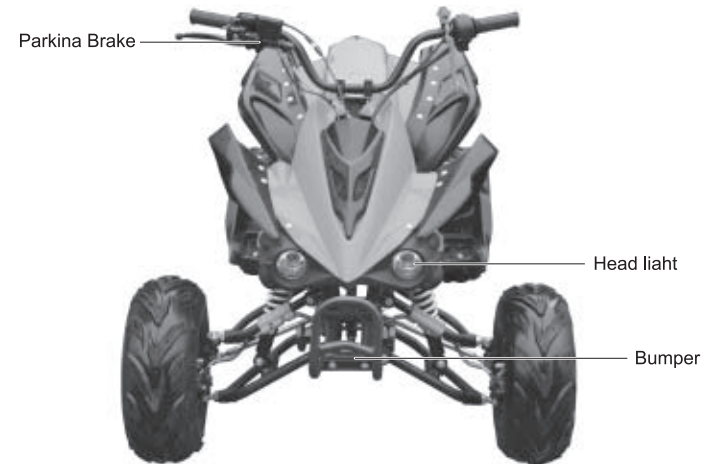
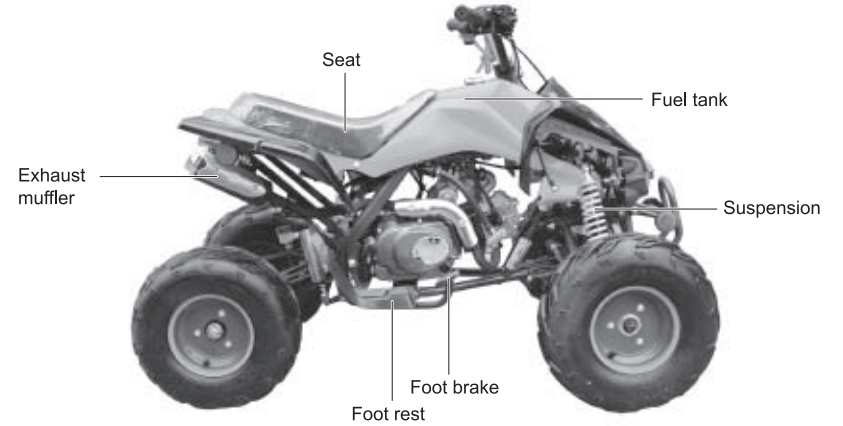

FOR Blazer 125U

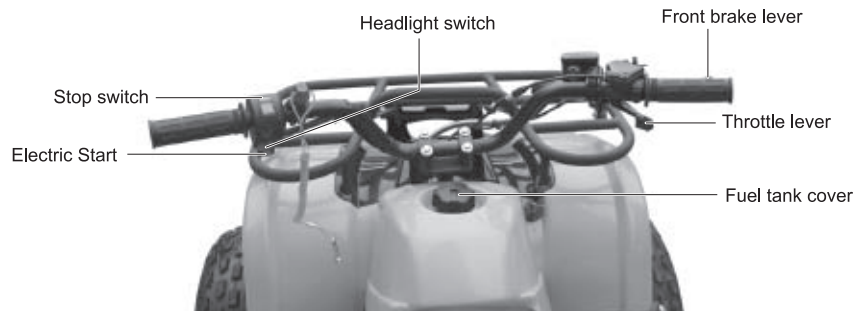
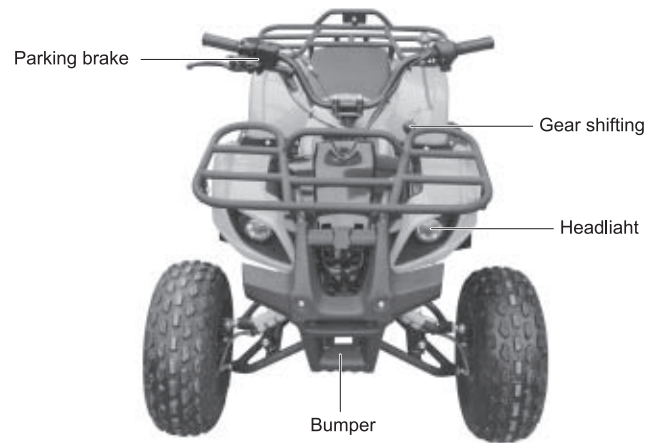
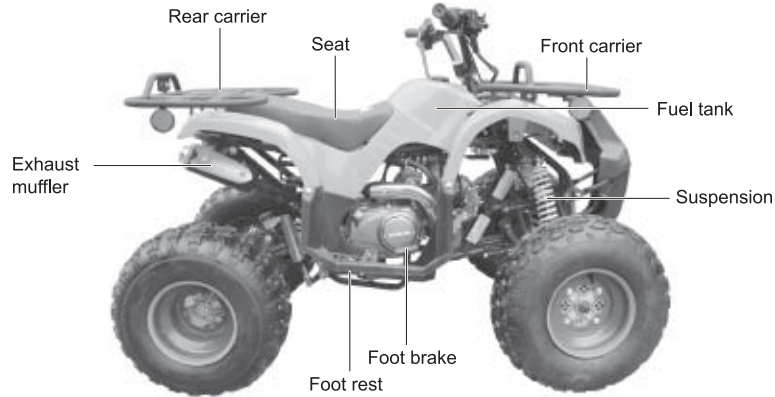

WARNING LABEL:

**⚠ WARNING**

Improper ATV use can result in SEVERE INJURY or DEATH

**ALWAYS USE AN APPROVED HELMET AND PROTECTIVE GEAR**  
**NEVER USE ON PUBLIC ROADS**  
**NEVER CARRY PASSENGERS**  
**NEVER USE WITH DRUGS OR ALCOHOL**

**NEVER operate:**

- without proper training or instruction
- at speeds too fast for your skills or the conditions
- on public roads - a collision can occur with another vehicle
- with a passenger - passengers affect balance and steering and increase risk of losing control

**ALWAYS:**

- use proper riding techniques to avoid vehicle overturns on hills and rough terrain and in turns
- avoid paved surfaces - pavement may seriously affect handling and control

**LOCATE AND READ OWNER'S MANUAL. FOLLOW ALL INSTRUCTIONS AND WARNINGS.**

**⚠ WARNING**

Improper tire pressure or overloading can cause loss of control. Loss of control can result in severe injury or death.

• Cold tire pressure:  
 Front : 10 ±0.5 psi (69±3.5 kPa)  
 Rear : 10 ±0.5 psi (69±3.5 kPa)  
 • Maximum weight capacity: 176lbs (80kg)

**⚠ WARNING**

**NEVER ride as a passenger.**

Passengers can cause a loss of control, resulting in SEVERE INJURY or DEATH.

**⚠ WARNING**

**UNDER 16**

Operating this ATV if you are under the age of 16, increases your chance of severe injury or death.

**NEVER operate this ATV if you are under age 16.**

CONTROLS  
LEFT HANDLEBAR



Engine stop switch

**"OFF" position**

The ignition is off, The engine cannot start or run

**"RUN" position**

The ignition circuit is on the engine can run.



**Engine start switch**

Depress the button with the vehicle while in braking mode to start the engine.  
Right handlebar

**Throttle lever**

With parking brake

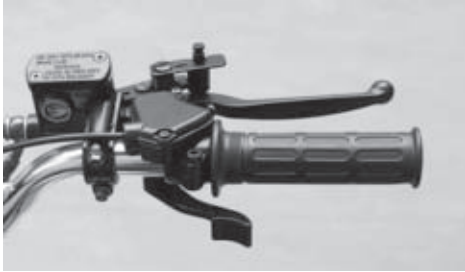
**Parking brake knob**

This knob is used to set the parking brake which is used to prevent the ATV from moving when it is parked, being started or at idle. Set the parking brake by squeezing the front brake lever and pushing the knob to lock the lever in the squeezed position.

Front brake lever

Apply the front brake by squeezing the front brake lever towards the grip

Engine speed is controlled by the position of the throttle lever. Push it forward to increase engine speed. Release it to decrease engine speed. This lever is operated by the rider's thumb.

**CHOKE LEVER**

When this lever is in the down position, a rich mixture is supplied by the carburetor for starting the engine when it is cold. When the lever is in the up position, the mixture supplied by the carburetor is optimum for starting a warm engine, and for normal operation.

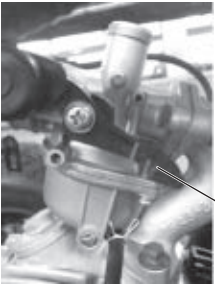

Chock lever

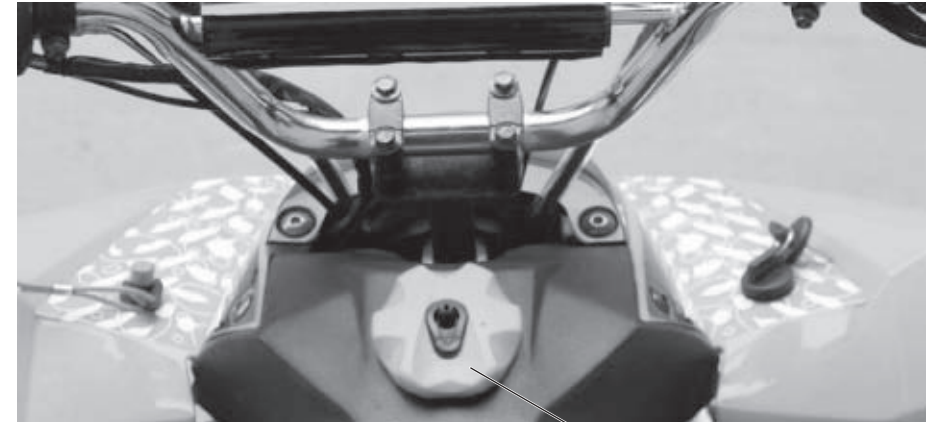
**EQUIPMENT AND ADJUSTMENTS****FUEL TANK CAP**

Fuel tank cap

To open the fuel tank cap, remove the end of the vent tube from the hole in the vehicle body and turn the fuel tank cap counterclockwise. To close the fuel tank cap, turn it clockwise and tighten it securely. Be sure that the end of the vent tube is reinstalled in the hole in the vehicle body and routed properly as shown.

**⚠ WARNING**

Do not overfill the fuel tank. Stop adding fuel when the fuel lever reaches the bottom of the filler neck as shown in the illustration. If you fill the tank beyond this level, fuel may overflow when it expands due to engine heat or by the sun.

**⚠ WARNING**

Gasoline is extremely flammable and toxic. Always observe the following precautions when refueling your ATV.

- Never permit vehicle refueling by anyone other than an adult.
- Refuel in a well ventilated area.
- Make sure the engine is off and avoid spilling fuel on a hot engine.
- Do not smoke; make sure that there are no open flames or sparks in the area.
- Avoid prolonged contact with skin and breathing of gasoline vapors.



### REMOTE ENGINE STOP SWITCH

The ATV comes equipped with a remote engine stop switch which may be operated by pulling the leash like lanyard attached to stop switch cap. An adult supervising operation of the vehicle can use the lanyard to stop the engine from a short distance. The adult who trains the young rider should always use this lanyard until the rider develops sufficient skills for safe operation of the vehicle.

This switch consists of a rubber cap fitted over a plastic body. When the rubber cap is in place, the engine can operate. When the rubber cap is removed from the switch body, the engine cannot be started. If the engine is running and the rubber cap is removed by pulling the lanyard attached to the cap, the engine will stop running.

To use the remote engine stop switch:

- Fit the rubber cap on the engine of the lanyard over the stop switch body located on the rear end of the vehicle as shown.

Put your fingers through the loop at the other end of the lanyard.

- With the lanyard fastened to the vehicle and to your hand, follow after the moving vehicle. If you notice any driving hazard or unsafe situation, pull the lanyard forcefully so that the rubber cap comes off. This will activate the remote engine stop switch, stopping the vehicle's engine.

#### **⚠ WARNING**

When the stop switch cap is pulled off, the engine will stop running. The vehicle will continue to roll for some distance, however. Remember this when judging when to operate the remote engine stop switch.

#### **⚠ WARNING**

If you do not put your fingers through the loop in the lanyard, it may slip from your grasp unexpectedly. This could make it impossible for you to stop the engine in an unsafe situation.

#### **⚠ WARNING**

The throttle limiter should always be set to the low power position when the engine stop lanyard is used. Only children.

With enough skill for safe operation of the ATV without parental use of the lanyard should be permitted to operate ATV with the throttle limiter set to maximum power position. In addition, an adult trying to follow a moving ATV with the throttle limiter set to maximum position may run into the rider if he stops, or may trip and fall down trying to keep up with the vehicle.

#### **Instruction for engine stop switch lanyard storage.**

The lanyard may be stowed on the ATV when, in judgment of the parents, the rider has developed sufficient skills to be able to safely operate the vehicle without parental use of the lanyard.

#### **⚠ WARNING**

To prevent unauthorized starting or unsupervised operation of the ATV, remove the stop switch cap and lanyard after each use and store then in a safe place, out of reach of children.

#### **BREAK-IN (RUNNING-IN)**

The first 1 month is the most important in the life of your vehicle. Proper operation during this break-in period will help ensure maximum life and performance from your new vehicle. The following guidelines explain proper break in procedures.

#### **MAXIMUM THROTTLE OPENING RECCOMENDATION**

During the first 10 hours of vehicle operation, the maximum throttle opening you should use is 1/2 throttle.

#### **VARY THE ENGINE SPEED**

The engine speed should varied during the break-in period. This allows the parts to be "loaded"(aiding the mating process) and then "unloaded" (allowing parts to cool). Although it is essential that some stress be placed on the engine components during break-in, you must be careful not to excessively load the engine.

#### **AVOID CONSTANT LOW SPEED**

Operating the engine at constant low speed (light load) can cause parts to glaze and not seat properly .Allow the engine to accelerate freely through the gears , without exceeding the maximum recommended throttle opening .

#### **OBSERVE YOUR INITIAL AND MOST CRITICAL SERVICE**

The initial sevice (break-in maintenance) is the most important service your vehicle will receive. During break in operation, all of the engine components will have mated together and seated. Maintenance required as part of the initial service includes correction of all adjustments, tightening of all fasteners and replacement of dirty oil.

Timely performance of this service will ensure optimum service life and performance from.

#### **INSPECTION BEFORE RIDING**

#### **⚠ WARNING**

Failure to perform an inspection before riding may result in an accident or serious damage to the vehicle. Check these items before each ride . Be sure your ATV is in good condition for the personal safety of the rider and protection of the vehicle.

#### **⚠ WARNING**

All of the items below should be checked with the engine off, except the functional check of the engine stop switch. Make sure your child doesn't get too close when you check the fuel level and drive chain, or he / she might be injured.

WHAT TO CHECK	CHECK FOR
STEERING	No rattle or looseness
Brakes	Proper lever play No "sponginess" Parking brake effectiveness
Tires	Proper pressure Enough tread depth No cracks , rips or other damage
Fuel	Enough fuel for the intended run Fuel hose connected securely No damage to fuel tank or cap Tank cap closed security
Engine stop switch	Proper operation
Engine oil	Proper level
Throttle	Proper cable play Smooth response Quick return to idle position
Drive chain	Adequate lubrication
General condition	Bolts and nuts are tight No rattle from any part of the machine with the engine running No visible evidence of damage
Remote engine stop switch (if used )	Proper operation No damage to rubber cap Secure attachment of lanyard to cap

### RIDING TIPS

Finish reading this "Riding Tips " section and then the "Instructing and Young Rider " section before starting the ATV or beginning riding instruction. This "riding Tips " section contains important operating information you will need to know before you go to the "Instructing the Young Rider " section will guide you in teaching young riders how to operate and ride the ATV using information you learn in this owner's manual.

### STARTING THE ENGINE

Before attempting to start the engine, make sure:

1. The parking brake is engaged.
2. The engine stop switch is in the " RUN " position.
3. Verify that the remote engine stop switch cap is in place.

#### When the engine is cold:

1. Push down the choke lever as for as it will go.

#### **⚠ WARNING**

2. Make sure that the choke lever can return smoothly to the off position before starting the engine.
3. With the throttle closed, start the engine by pulling up on the recoil starter roper forcefully.
4. Return the choke lever all the way back to its disengaged position.

#### When the engine is warm:

Operation of the choke system should not be necessary. Open the throttle slightly and start the engine by pulling up on the recoil starter rope forcefully.

#### **⚠ WARNING**

Release the throttle immediately after the engine has started.

#### **⚠ WARNING**

1. Do not run the engine indoors or where there is little or no ventilation. Exhaust gases contain carbon monoxide, a potentially lethal gas that is colorless and odorless.
2. Never leave the vehicle running while unattended, even though for a short time.

### STARTING OFF

After the engine has warmed up, disengage the parking brake. To release the parking brake, simply squeeze the brake lever until the lock knob disengages.

#### **⚠ WARNING**

Before releasing the parking brake, make sure:

1. The choke lever has been returned to the fully OFF position.
2. The choke lever is fully closed.
3. The rider is completely ready to ride.

If you do not observe these precautions, the vehicle can move forward unexpectedly when the parking brake is released. This may result in an accident and injury.

#### **⚠ WARNING**

While operating the ATV, the rider should keep both feet on the footrest all all times, or injuries resulting from accidents such as the rear wheels running over the rider's feet could occur. There is no need for the rider to move his/her feet from the footrests during operation or maneuvering of the vehicle. Moving the rider's feet from the footrests reduces the rider's ability to control the vehicle, and could lead to an accident.

#### **⚠ WARNING**

Keep both hands on the handgrips at all times when riding removing your hands from the handgrips reduces your ability to control the vehicle, and could result in an accident.

#### **⚠ WARNING**

Always open the throttle gradually to prevent front wheel lifting failure to observe this precaution may result in loss of control and an accident or injury.

### BRAKING

To stop the ATV release the throttle lever and apply the brake.

#### **⚠ WARNING**

1. Avoid braking during turns. Use of the brake when turning could cause the ATV to slide or roll over. Use the brake to slow down before entering the turn.
2. Apply the brake lightly and with great care on slippery surfaces to avoid skidding.

**⚠ WARNING**

Never apply the parking brake lock when the ATV is moving. Rear wheels will lock, and an accident could result with injury.

**TURNING**

To turn the ATV, the rider must learn a special technique, because its vehicle has a solid rear axle, both rear wheels always turn at the same speed. This means that if the rear wheels are getting equal traction, the vehicle will move straight ahead, because the rear wheels will travel the same distance. For the vehicle to turn, the outside rear wheel must travel a greater distance than the inside rear wheel. To make this happen, the rider must learn how to create less traction for the inside wheel, so that it can travel a shorter distance than the outside wheel, even though both wheels at the same speed.

To turn the ATV the rider should use the following technique:

1. Turn the handlebars in the direction of the turn.
2. Shift body weight slightly forward and support your weight on the outer footrest. This will reduce the load on the inside rear wheel, reducing its traction.
3. Lean upper body into the turn.

**TURNING AT HIGHER SPEEDS**

Use the same technique that you use for turning at low speeds, but lean farther into the turn. Since natural turning forces (which tend to push the vehicle to the outside of the turn) increase as speed increases, you must lean your upper body farther into the turn as you go faster, to the outside of the turn. Remember though to keep your weight supported on the outer footrest.

**⚠ WARNING**

If the rider does not use the proper technique to turn the ATV, it may plow straight ahead even though the front wheels are turned.

The rider should practice the above technique at low speeds in a wide open area until he/she has mastered it.

**SKIDDING OR SLIDING**

If the rider experiences inadvertent skidding or sliding when not braking, he/she may be able to overcome it by using the appropriate technique listed below.

**Front wheel:**

If front wheel skidding occurs, try to gain front wheel traction by reducing the throttle opening and leaning your body weight slightly forward.

**Rear wheel:**

If rear wheel skidding occurs, steer in the direction of the skid (if space permits), shift body away from the skid slightly, and avoid using the throttle or brakes until you regain directional control of the vehicle.

**⚠ WARNING**

Skidding or sliding can result in an accident caused by loss of rider control. To avoid inadvertent skidding or sliding, the rider should slow down and be very cautious when riding on slippery or loose surfaces.

**OPERATION ON HILLS**

Riders who have become experienced at operating the ATV on level surfaces may wish to try riding on a wider variety of terrains. The ATV may be operated on a small hill with even surfaces but extreme care should be taken.

**⚠ WARNING**

When the ATV is operated on hills, it can roll over more easily than when it is operated on level ground, under certain conditions, only children who are capable of safe operation of the ATV on level ground should be permitted to operate the vehicle on hills.

**Climbing a hill**

To climb a small hill with the ATV the rider should:

1. Speed up and maintain a steady speed before reaching the bottom of the hill.
2. Shift body weight forward by sliding forward on the seat, lean slightly forward.
3. Maintain a steady speed while climbing the hill.
4. Slow down when reaching the top of the hill.

**⚠ WARNING**

Only permit your child to climb small hills. Do not let him /she attempt to climb a hill unless you are sure that he /she can easily ride to the top of the hill without stopping. It can be dangerous to stop the ATV while climbing a hill, because the vehicle may begin to roll backwards and then roll over backwards.

The rider should never open the throttle suddenly when climbing a hill, the vehicle could flip over backwards.

The rider should never go over the top of the hill at high speed. Once over the top of the hill, he /she could lose control and crash or could collide with an unseen object.

If your child is climbing a hill and lose forward momentum, he /she should:

1. Lean farther forward, uphill.
2. Apply the rear brake and stop the vehicle before it starts to roll backwards.
3. Set the parking brake and dismount to the right while still leaning uphill.
4. Use one of the following procedures to turn the vehicle around :

- 1) Ask the adult who is supervising to help drag the rear end of the ATV around until the vehicle is angled downhill. Stay on the uphill side of the vehicle while dragging it around.
- 2) Turn the handlebars fully to the right .while standing on the uphill side of the vehicle, release the parking brake and pump the handbrake to let the ATV roll slowly backwards. This will turn the vehicle sideways to the hill. Reset the parking brake. Turn the handlebars to the left. Staying on the uphill side, release the parking brake and pump the handbrake to let the ATV roll until it is angled downhill. Reset the parking brake.

### Descending a hill

To ride down a small hill with the ATV, the rider should:

1. Point the ATV straight downhill.
  2. Transfer body weight to the rear by sliding back on the seat.
  3. Ride down the hill with the throttle closed
- Apply the brake to control downhill speed.

### Traversing a slope

#### WARNING

Traversing a slope is very tricky and should be avoided when possible. Improper riding techniques while traversing a slope could cause the ATV to tip over. Do not permit your child to traverse a slope unless you are sure he/she can perform this maneuver safely.

To traverse a slope, the rider should:

1. Lean his/her body uphill.
2. Steer slightly uphill, if necessary, to maintain a straight course.

### RIDING THROUGH WATER

The ATV may be ridden through water, provide that it not more than 15cm(6inches),deep and is not moving fast. When crossing a stream, choose a spot where the banks are gently sloped on both sides and bottom of the stream is hard. If you are unfamiliar with the area you wish to cross, park the ATV and inspect the stream first, to find a suitable spot for crossing. When crossing, operate the vehicle at a slow, steady speed.

#### WARNING

1. Do not attempt to cross a stream with deep or fast flowing water. The tires may lose their traction, and you may be unable to control the vehicle. This could result in personal injury.
2. After riding through water, test the brakes to see if they have maintained their more effectiveness. If they are less effective than normal, dry them by repeatedly applying the front and rear while riding slowly until the brakes have regained their normal effectiveness.

### Caution:

After extended operation of the ATV in water, bring it to your authorized dealer to have the brakes inspected and cleaned, if necessary. Failure to take this precaution can result in excessive brake wear.

### STOPPING THE ENGINE

Release the throttle lever. Turn the engine stop switch to the 'OFF ' position.

### PARKING THE VEHICLE

Set the parking brake securely as explained in the "STARTING THE ENGINE" section.

#### WARNING

It takes some time for the engine and muffler to cool off after a long ride. Do not touch these parts until they have had time to cool off, or you may burn yourself.

### INSTRUCTING THE YOUNG RIDER

#### IMPORTANT ADVICE TO THE PARENT:

Your child's safety depends on your commitment to take the time necessary to fully educate him /her on the proper operation of the ATV. Remember that proper instruction before your child begins to ride is just as important as proper instruction and supervision during riding.

Please go through this manual with your child, page by page and fully explain all of the instructions, requirements and warnings it contains. Be sure to put as much emphasis on safety precautions as on proper operational techniques. Question your child as you go through the manual to make sure he /she understands what you are saying.

Following is a step by step guide to help your child's first use of the ATV a safe and enjoyable experience. Before you begin to use this guide, however, be sure you have reviewed the vehicle features and riding techniques described in earlier parts of this owner's manual. Our company strongly urges that you use this guide to teach each child that you let ride the ATV.

Be sure to take breaks as the child being instructed gets tired or his /her attention begins to wander. Full attention at all times is needed to safely operate any motorized vehicle, including the ATV.

### PROPER CLOTHING AND PROTECTIVE WEAR

The first step to safe riding is proper protection of the rider, your child should always wear a helmet, eye protection, gloves, long pants, a long sleeved shirt or jacket and boots. Make sure that your child is not wearing any loose fitting clothes .loose belts, scarves, etc. Can get caught in moving parts and cause personal injury. Even in hot weather, make sure the child wears long pants and a long sleeved shirt. These not only protect against abrasive injuries, but also help to reduce fatigue which comes from loss of body heat due to the wind.



**⚠ WARNING**

Failure to wear proper clothing and protective wear , as described above , may result in severe personal injury .

**FAMILIARIZATION WITH THE VEHICLE**

Your child should become completely familiar with the names and functions of all controls. Let the young rider sit on the ATV with the engine off, and ask him /her to operate specific controls. Demonstrate operation of the controls if necessary. Ask the child to do such things as ' apply the brakes, turn off the engine, lock the parking brake ', etc. Practice this exercise until the child can operate all of the controls without hesitation and without looking at the controls.

go over the **INSPECTION BEFORE RIDING** with your child until he /she knows all of the items that should be checked and how they should be checked . Give specific examples of things to look for.

**STARTING OFF AND STOPPING****⚠ WARNING**

For practice, choose a large, level area away from other riders and free of obstructions. Inspect the area before riders and remove any rocks, sticks or other potential hazards. Stay away from ditches and bumps.

To help your child develop confidence, he /she should **PRACTICE FIRST WITH THE ENGINE OFF**, as follows:

1. Have your child sit on the ATV and tell him /her to release the parking brake
2. Instruct your child to keep his/her eyes straight ahead and slowly push the vehicle from behind, if you are physically able to do so. This will allow your child to get the feel of riding a moving vehicle.
3. As you push the ATV instruct your child to steer straight ahead and perform operations such as stopping the vehicle and turning off the engine stop switch while moving, watch your child closely to make sure he/she is operating the controls correctly and without looking at the controls.
4. As you approach the end of the practice area, tell the rider to stop the vehicle, apply the parking brake, and get off. You should then drag the rear end of the ATV around so you can push it straight ahead in the opposite direction.

**⚠ WARNING**

Before permitting your child to operate the ATV under power, be sure to adjust the throttle limiter to provide a low maximum speed capability. Turning the limiter clockwise reduces the ATV's maximum speed capability.

Next start the ATV's engine and have your child practice starting off riding in a straight line, and stopping, with the vehicle under power. Walk along side the ATV if you can, or have the youngster ride back and forth between you and another supervisor. Watch closely to make sure the rider:

1. Opens the throttle gently when starting off.
2. Releases the throttle and applies the brake in sequence when stopping
3. Becomes aware of the distance it takes the vehicle to stop when the engine stop switch is turned off while the vehicle is moving.

As you approach the end of the practice area, you should again tell the rider to stop the vehicle, apply the parking brake, and get off so you can turn it around for him/her. Practice this exercise until your child can start off, accelerate, cruise, and stop correctly and with confidence.

**TURNING**

After your child has learned to ride the ATV in a straight line and can stop it when he/she want to, you should teach the child how to turn the vehicle. Explain the proper body movements for turning, and let your child **PRACTICE FIRST WITH THE ENGINE OFF**, as you push the vehicle from behind. When turning, watch to make sure your child:

1. Shift this/her weight slightly forward and supports his/her weight on the outer footrest.
2. Leans his /her upper body into the turn and turns the handlebar in the direction of the turn.

When the rider is able to properly turn the ATV in both directions with the engine off, he /she should practice with the vehicle under power. Again, make sure that the throttle limiter is adjusted to provide a low maximum speed capability. Watch closely to make sure the rider is using the proper turning technique. The rider should practice turning until he /she can do it correctly and with confidence.

**PUTTING IT ALL TOGETHER**

When your child has mastered the basic riding maneuvers in the previous steps, he /she should practice putting them all together, instruct the rider to perform various maneuvers such as turning right, turning left, stopping parking, etc. Mix up the order of these maneuvers so the child will not know what he /she will be asked to do next. Practice this exercise until you are confident that the rider has mastered all the basic maneuvers.

The above steps will help the first time rider learn the most basic riding techniques. To become a skilled rider, your child will need a great deal of practice and instruction after these steps have been completed. Be patient with your child; take extra time when teaching him/ her additional techniques such as the recommended techniques for climbing and descending hills.

After your child has mastered the basic riding or all techniques at slow speeds, you can adjust the throttle limiter to provide higher speed capabilities according to the rider's skill and experience.

**INSPECTION AND MAINTENANCE MAINTENANCE SCHEDULE**

It is very important to inspect and maintain your ATV regularly .follow the chart below. Chart indicates the intervals between periodic services in months. At the end of each interval, be sure to inspect, adjust, lubricate, replace, and service as indicated.

**⚠ WARNING**

Company recommends that maintenance on those items, in the chart below which are marked with an asterisk (\*) be performed by your Authorized dealer or a qualified service mechanic .if you are qualified, you may perform maintenance on the unmarked items by referring to the instructions in this section. If you are not sure whether you can successfully complete any of the unmarked maintenance jobs, ask your authorized dealer to do the maintenance for you.

**⚠ WARNING**

Do not attempt to perform maintenance on this vehicle if you are not qualified. You could be injured or mat damage the machine.

**⚠ WARNING**

The safety of the rider depends on how well this machine is maintained. Follow all inspection and maintenance instructions carefully.

**⚠ WARNING**

Don't let your children tinker with this machine. They may get hurt. Maintenance should only be performed by qualified adults. Make sure that the engine stop switch is in the ' OFF ' position unless the engine must be running to perform the required maintenance.

**CAUTION:**

The maintenance intervals shown in the chart below are based on average riding conditions .if the ATV is ridden in a dusty area , the air cleaner and drive chain should be serviced more frequently if the vehicle is operated under extreme conditions .if you have any questions regarding appropriate maintenance intervals , consult your authorized dealer.

**PERIODIC MAINTENANCE CHART**

NOTE: inspect and clean, adjust, lubricate, or replace, if necessary.

Item Interval	After 1 month	Every 3 month	Every 6 month
Air cleaner elements	Clean at least every month		
Spark plug		C	R
Cylinder head and exhaust parts	Tighten cylinder head nuts	Every 3 month	Remove carbon
Carburetor	Adjust throttle valve stop screw and pilot screw	Every 3 month	Adjust throttle valve stop screw and pilot screw
Fuel line			
	Replace every 4 years		
Engine oil	R		R
Drive chain	Inspect every month		
sprockets			
Tires	Inspect every month		
brakes			
Steering			
Chassis nuts and bolts	T	T	
General lubrication		L	

### SEAT REMOVAL

Remove the seat by pulling the seat lock lever upward and pull up the seat at the rear. Insert the projection on the front of the seat into the holder and push down on the seat at rear to install the seat.

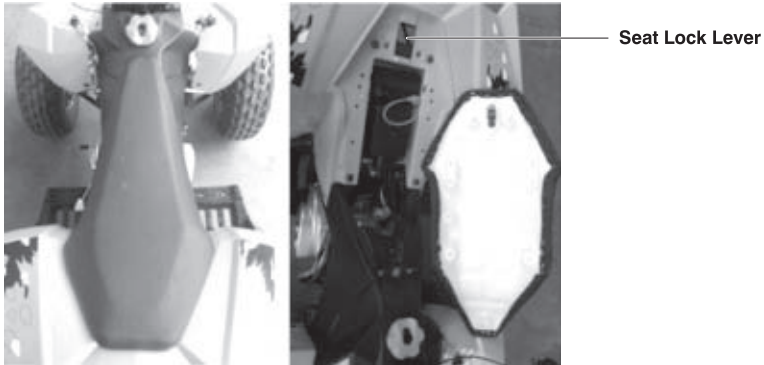

### CAUTION:

Always make sure the seat is securely fitted.

### AIR CLEANER

If the air cleaner element is clogged with dust, there will be greater intake resistance, resulting in decreased power output and increased fuel consumption.

### CAUTION:

1. Do not operate the engine without the air cleaner element in place or severe damage may result.
2. If you usually ride in dusty areas or regularly operate the vehicle wet, muddy conditions, you must inspect the air cleaner element more frequently than shown in the periodic maintenance chart. If at any time, the air cleaner element is submerged in water, immediately clean the element and the inside of the air cleaner case.

### SPARK PLUG

Your ATV comes equipped with an AT7C OR A7RTC spark plug. You can determine if the standard spark plug is suitable for your type of vehicle usage by observing the color of the plug's porcelain center electrode insulator after vehicle operation. If the plug has the correct heat range, it should be very light brown in color. If the plug tends to run to cold, (usually evidenced by blackening of the insulator or a wet electrode) replace it with an alternate plug according to the following chart.

### CAUTION:

An improper spark plug may have an incorrect fit or heat range for your engine, this may cause severe engine damage which may not be covered under warranty. Use one of the spark plugs listed below or equivalents. Consult your dealer if you are not sure which spark plug is correct for your type of vehicle usage.

### ⚠ WARNING

To install a spark plug, turn it in as far as possible with your fingers, and then tighten it with a wrench. Do not over tighten or cross thread the spark plug, or the aluminum thread of the cylinder will be damaged. Do not allow contaminants to enter the engine through the spark plug hole when the plug is removed.

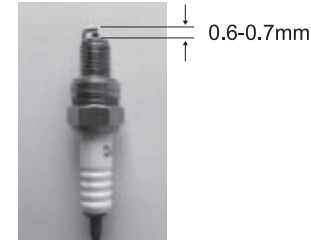

To maintain a hot, strong spark, keep the plug free of carbon. Remove carbon from the plug with a wire or pin, and adjust the gap to 0.6-0.7mm for good ignition. Use a thickness gauge to check the gap.

### IDLE SPEED ADJUSTMENT

To adjust the idle speed properly, you need a tachometer, if you do not have one, ask your dealer to perform this adjustment.

To adjust the idle speed:

1. Start the engine and warm it up.
2. After engine warms up, turn the throttle stop screw in or out so that the engine idles at



Idling speed adjusting screw

### CAUTION:

Make sure that the engine is fully warmed up before adjusting the engine idle speed. Improper adjustment can result in increased engine wear, lowest steady speed.

### THROTTLE CABLE ADJUSTMENT

Measure the throttle cable play by pressing the throttle lever. The throttle lever should have 20~25mm play.

To adjust the throttle cable play:

1. Loosen the lock nut
2. Turn the adjuster in or out to obtain the correct play
3. Tighten the lock nut
4. Recheck the throttle cable play. Readjust it if it is not within the correct limits



### FUEL HOSE

Replace the fuel hose every 4 years, even if it appears to be in good condition. Damage from aging may not be visible.

### ENGINE OIL

The transmission oil should always be changed when the engine is hot so that the oil's viscosity will be low and the oil will drain completely from the engine.

To change the oil:

1. Place the vehicle on level ground
2. Remove the oil filler cap
3. Remove the oil drain plug from the bottom of the engine and drain the oil completely
4. Reinstall the drain
5. Remove the oil level screw and pour fresh oil of the specified type through the filler hole until the oil flows out from the oil level hole.

Note: Approximately 500ml (0.5/0.4 US/imp qt) of oil is required.

### CAUTION:

Frequent use in wet conditions will require more frequent oil change. If the vehicle becomes submerged in water, immediately change the oil. Failure to follow this instruction may result in severe transmission damage.

### BRAKE

The ATV has rear disk brake

#### ⚠ WARNING

Failure to properly inspect and maintain your ATV's brake systems can be hazardous.

Improper maintenance of the brakes increases your chances of having an accident.

Be sure to inspect the brakes before each use of the vehicle according to the inspection before riding section. Always maintain your breaks according to the Maintenance Schedule

#### ⚠ WARNING

Operating the ATV in harsh conditions can be hazardous if you do not inspect brake wear often. Operating in mud, water, sand, or other extreme conditions can cause accelerated brake wear. This could lead to an accident.

If you operate your vehicle under these conditions. The brakes must be inspected more often than recommended in the Maintenance Schedule.

### Brake Adjustment

Increase brake function, making the vehicle brake more steady.

1. Set the parking brake by squeezing the brake lever and pressing the lock knob.
2. Try to move the vehicle backward and forward to see if the rear wheels are securely locked. If the rear wheels can turn, adjust the brake to lock the wheels securely by releasing the parking brake
3. If can't check it:

#### a. Brake oil

The brake oil crock must be kept between the upper and lower mark. The brake friction must be checked to see if it is damaged once the limit depth, then there may be leakage in the brake oil crock. You should turn to the after-sale service station for inquiry.

If brake oil is ok, adjusting the air nut, let air education the down-pump, then lock the nut.

#### b. Brake friction

During the maintain period, the abrasion can be examed by eye. Once either friction pads is worn the limit depth, replace both pads in time. The tube and lining fitting must examed to ensure that the brake oil never be leakage.

Repeat this procedure until the parking brake is properly adjusted

4. Measure the amount of free play needed to lick the brake lever. Adjust the brake, if necessary, so that amount of free play is about 5mm (0.2in)
5. After any adjustment of the brake, check again to make sure the rear wheels can not turn then the parking brake lock knob is engaged.

### RECOIL STARTER ENGAGEMENT ADJUSTMENT

#### ⚠ WARNING

Before adjusting the recoil starter, make sure the engine stop switch is in the OFF position so the engine can not be started accidentally.

To adjust the recoil starter, use the following procedure:

1. Loosen the adjuster lock nut and turn the recoil adjuster clockwise as far as it will go.
2. Set the parking brake and make sure that the rear wheels are locked.
3. Turn the recoil adjuster counterclockwise by a half turn and pull the starter grip slowly to see if the ratchet engages and engine can be cranked. If the recoil starter counterclockwise by another half turn. Repeat this procedure until the starter ratchet mechanism begins to engage.



4. After locating the point where the starter ratchet begins to engage, turn the recoil adjuster counterclockwise 1 1/2 more turns and secure it by tightening the adjuster lock nut.
5. Check again to make sure that the recoil starter ratchet engages after the adjuster lock nut has been tightened.

## TIRES

### ⚠ WARNING

Using tires of a different size or type than the tires originally equipped on your ATV can change the ATV's handling characteristics. Different handling characteristics can result from differences in carcass construction, sidewall strength, thread pattern, etc.

### ⚠ WARNING

For the rider's safety, check your vehicle's tires before each use of the vehicle, to make sure they have proper pressure, enough thread depth, and no damage.

### ⚠ WARNING

Operating the vehicle with excessively worn tires can cause skidding due to decreased traction. It is recommended that the front and rear tires be replaced when the depth of the tire thread is 4mm (0.16in) or less.

### Tire pressure

A low pressure gauge is provided in the tool kit under the seat, so you can measure the air pressure in your ATV tires. Check the air pressure in all tires before each use of the vehicle. Improper air pressure can affect handling, maneuverability, traction, tire life and rider comfort. Be sure that the tires are inflated to the pressure shown below. Tire pressure should only be measured or adjusted when the tires are old, or misleading measurements can result.

### Caution:

Using a high pressure air pump to fill the tires can be hazardous. If too much air is put into a tire, the tire may burst, causing severe injury. Use a manual type air pump to fill the tires.

### Tire replacement

Air in the low-pressure tubeless tires of this vehicle is sealed by the contact surfaces of the inner wheel rim and tire bead. If either the inner wheel rim or tire bead is damaged, air may leak. Be extremely careful not to damage these sections when replacing tires.

When breaking the tire bead loose from the wheel, be

extremely careful not to damage the inner surface or the tire bead.

### ⚠ WARNING

The ATV's tires are intended to rotate in a specific direction, as indicated by the arrows on the sidewall of each tire. Be sure to install tires so they rotate in the proper direction or you may experience poor handling.

It is very important to use the proper tools when repairing or replacing tires, to prevent damage to the tire bead or wheel rims. We highly recommend that you have work done by your dealer or qualified tire repair station.

### Tubeless tire repair

Should a leak or flat tire occur due to a puncture, the tire may be repaired using a "Plug" type patch. If the damage is from a cut, or if the puncture cannot be repaired using a plug, the tire should be replaced. When operating your ATV in areas where transportation or service facilities are not readily available, it is strongly recommended that you bring a plug type repair kit and a tire pump with you.

### DRIVE CHAIN

The condition and adjustment of the drive chain should be checked once a month. Always follow the guidelines below for inspection and servicing the chain.

You should periodically inspect the drive chain for the following:

- Loose pins
- Damaged rollers
- Dry or rusted links
- Kinked or binding links
- Excessive wear

If you find anything wrong with the drive chain condition or adjustment, there is a strong possibility that the sprockets will have damage to them also. Inspect the sprockets for the following:

- Excessively worn teeth
- Broken or damaged teeth

### Drive chain cleaning and oiling

Clean and oil the chain as follows:

1. Wash the chain with kerosene. Kerosene is a petroleum product and will provide some lubrication as well as cleaning action.

### ⚠ WARNING

Keep kerosene away from children and pets. Dispose of used kerosene properly.



**Caution:**

Do not use gasoline, Trichlene or other commercial cleaning solvents to clean the drive chain. These fluids have a strong dissolving power that could damage the "O" rings in the chain. Damage to the "O" rings would allow the grease to run out of the chain and the chain would have to be replaced.

2. After thoroughly washing the chain and allowing it to dry, oil the links with a heavy weight motor oil(40 or 50 weight)

**Caution:**

Some lubricants which are sold as drive chain lubricant can damage "O" rings of your vehicle's chain. Sue the recommended motor oil or a lubricant that is especially intended for use on "O" ring chains.

**⚠ WARNING**

Failure to inspect the drive chain slack before each use of the ATV could be hazardous. Too much chain slack could cause the chain to come off the sprockets, resulting in an accident or serious damage to the ATV.

Inspect the drive chain slack before each use.

**FRONT AND REAR WHEEL REMOVAL**

Front Wheel

Rear Wheel

1. Place the vehicle on level ground and set the parking brake.
2. Loosen the three wheel nuts on the wheel to be removed.
3. Lift up the front or rear end of the vehicle by placing a jack or block under the axle or frame.
4. Remove the three wheel nuts.
5. Remove the wheel. Reinstall the wheel, reverse these steps

**⚠ WARNING**

When replacing a wheel, it is very important that the wheel nuts be torqued to the proper specifications. If they are not, the wheel can come off unexpectedly. We strongly recommends that you have these nuts checked and torqued, if necessary, by your authorized dealer.

**General Lubrication**

Proper lubrication is important for safe smooth operation and long life of each working parts of your vehicle. Pay attention to the need for lubrication when you perform periodic maintenance on the vehicle. Be sure to have your authorized dealer perform a general lubrication as shown in the maintenance chart on page 24. Your authorized dealer will lubricate such items as wheel bearings, rear axle housing, steering shaft holder, etc.

**TROUBLE SHOOTING****Caution:**

It is best to consult your dealer before attempting to troubleshoot any problem. Damage may result from inappropriate repairs or adjustments. Such damage may not be covered under warranty.

This troubleshooting guide is provided to help you identify the cause of some common complaints.

Problem: Engine is hard to start or does not start at all.

Something is probably wrong with the fuel or ignition system.

**Fuel system check**

1. Make sure there is adequate fuel in the fuel tank.
2. Check that the engine stop switch is in the "RUN" position
3. Check that the remote engine stop switch cap is installed on the remote engine stop switch
4. Make sure there is enough fuel reaching the carburetor from the fuel tank
  - a. Loosen the drain screw which is located under the carburetor and drain the fuel from the carburetor

**⚠ WARNING**

Do not allow the fuel to spill. Catch the fuel in a container. Do not allow any fuel to come in contact with the hot engine or exhaust system. Extinguish any smoking materials before performing this check, and stay away from any open flames or heat sources.

- b. Tighten the drain screw
- c. Remove the spark plug and pull the recoil starter
- d. Loosen the drain screw and check that the carburetor is filled back up with fuel.
- e. If it has been determined that fuel is reaching the carburetor, the ignition system should be checked next.

**Ignition system check**

1. Remove the spark plug and reattach it to the spark plug lead.
2. While holding the spark plug firmly against the engine, push the starter button with the engine stop switch switch cap is installed on the remote engine stop switch. If the ignition system is operating properly, a blue spark should jump across the park plug gap. If there is no spark, take

**⚠ WARNING**

Do not check for a spark unless you are certain that you know how to do it; you could get a high voltage electrical shock. When testing for a spark, do not point the spark plug near the spark plug hole. There may some fuel inside the cylinder which could be ignited. Due the possibility of electrical shock, anyone with a heart condition or pacemaker should avoid this check.

**PROBLEM: Engine stalls**

1. Make sure there is enough fuel in the fuel tank.
2. Check to see that the spark plug is not fouled. Remove the plug and decarbon or replace it, if necessary.
3. Make sure the fuel valve is clear. Also check the air vent hose connected to the fuel tank cap is not clogged.

**TRANSPORTATION**

The ATV should be transported in the normal position if possible. It may also be transported in the standing position, but the standing position is not stable as the normal position.

Before transporting the ATV, drain the fuel from the carburetor as follows:

1. Turn the fuel valve lever to the ON position.
2. Drain fuel from the carburetor into a suitable container by loosening the carburetor drain bolt.
3. When the fuel has drained completely, retighten the drain bolt.

**⚠ WARNING**

When draining the carburetor, always shut the engine off. Do not smoke, never drain, or refuel in an area where there are open flames or sparks.

**⚠ WARNING**

Be sure to use a suitable container to catch the fuel ou drain from the carburetor. Do not allow the fuel to spill or you may create a fire hazard. Keep fuel out of the reach of children and pets or they may be injured, and dispose of unwanted fuel properly.

**⚠ WARNING**

When transporting the ATV, lock the parking brake and tire down the vehicle securely with rope or some other suitable means. Use extra tie downs when you transport the vehicle in the standing position. Failure to properly secure the vehicle may result in an accident or damage to the vehicle.

**STARTING AFTER TRANSPORT**

To feed fuel into the carburetor, turn the fuel vale to the PRI position.

**CLEANING PROCEDURE**

A Thorough cleaning of your ATV is a necessary parts of Maintenance and will help keep your ATV looking and performing its best. Proper cleaning can also extend the life of your ATV.

It is important to clean and inspect your ATV after every ride if it used in mud, brush, grass, water, salt water, or every dusty conditions.

The buildup of mud, brush grass, ect., especially on the engine and exhaust system. Can reduce engine cooling, conceal damage, or increase wear of certain parts. It is important to remove all debris during cleaning.

**PREPARATION FOR CLEARING**

Wash the ATV before any mud dries on the ATV.

Block or seal the end of the exhaust pipe using a piece of plastic wrap, cloth rag or another method to prevent water from entering the engine.

High pressure washers can damage your ATV.

**Caution:**

High pressure washers such as those found at coin-operated car washes have enough pressure to damage the parts of your ATV. It may cause rust, corrosion and increase wear.

Do not sure high pressure washers to clean your ATV.

**WASHING YOUR ATV**

With some care, your AV can be washed in a similar manner to washing an automobile.

Note: Avoid spraying or allowing water to flow over the following places:

Spark plug

Fuel tank cap

Carburetor

Snorkel air intake for air filter and carburetor (The snorkel air intake opening is located at the highest point on the ATV, usually in front of the seat)

Use a garden hose at low pressure to remove the majority of dirt or other debris. Hand wash your ATV with a mild soap or detergent and water. Try to thoroughly remove all dirt and debris without excessive water pressure, even at remote areas such as between engine cooling fins, linkages or mounting brackets. Cloth rags, washing mitts or cleaning brushes can be used. Be careful with brushes as they may scratch plastic or painted surfaces. Rinse the ATV thoroughly with clean water. Dry all areas using a chamois or soft absorbent cloth.

**INSPECTION AFTER CLEANING**

Remove the rags or wrapping from the exhaust pipe. Check the drain tubes on the bottom of the air filter box and drain any water than has collected in them. For extended life of your ATV, lubricate according to GENERAL LUBRICATION section.

**⚠ WARNING**

Operating ATV with wet brakes can be hazardous.

Wet brakes may not provide as much stopping power as dry brakes, This could lead to an accident.

Test your brakes after washing ATV, while riding at slow speed. If necessary, apply brakes several times to let the friction dry out the linings.

Follow the procedures in the **INSPECTION BEFORE RIDING** section to check your ATV for any problems that may have arisen during your last ride.

**STORAGE PROCEDURE**

If your ATV is to be left unused for an extended period of time, it needs special servicing requiring appropriate materials, equipment, and skill. For this reason, Company recommends that you trust this maintenance work to your dealer. If you wish to service the machine for a storage yourself, follow the general guidelines below:

**VEHICLE**

Place the vehicle on level ground and thoroughly clean the entire vehicle.

**FUEL**

Drain the fuel from the fuel tank using a commercially available hand pump or siphon. Drain the fuel from the carburetor using the carburetor drain screw

**⚠ WARNING**

Do not allow the fuel to spill; catch the fuel in a suitable container. Do not allow fuel to come in contact with the hot engine or exhaust system. Extinguish smoking materials before draining any fuel and stay away from any other fire or heat source. Keep pets and children away from fuel, and dispose of unwanted fuel properly.

**ENGINE**

Pour on tablespoon of motor oil into spark plug hole, Reinstall the spark plug and crank the engine a few times.

**TIRES**

Inflate tires to normal specifications.

**EXTERNAL**

Spray all vinyl and rubber parts with rubber preservative.

Spray unpainted surfaces with rust preventative.

Coat painted surfaces with car wax.

**PROCEDURE FOR RETURNING TO SERVICE**

Clean the entire vehicle

Remove the spark plug. Turn the engine a few times by pulling the pull start. Reinstall the spark plug.

Make sure that the vehicle is properly lubricated.

Perform the **INSPECTION BEFORE RIDING** as listed in this manual.

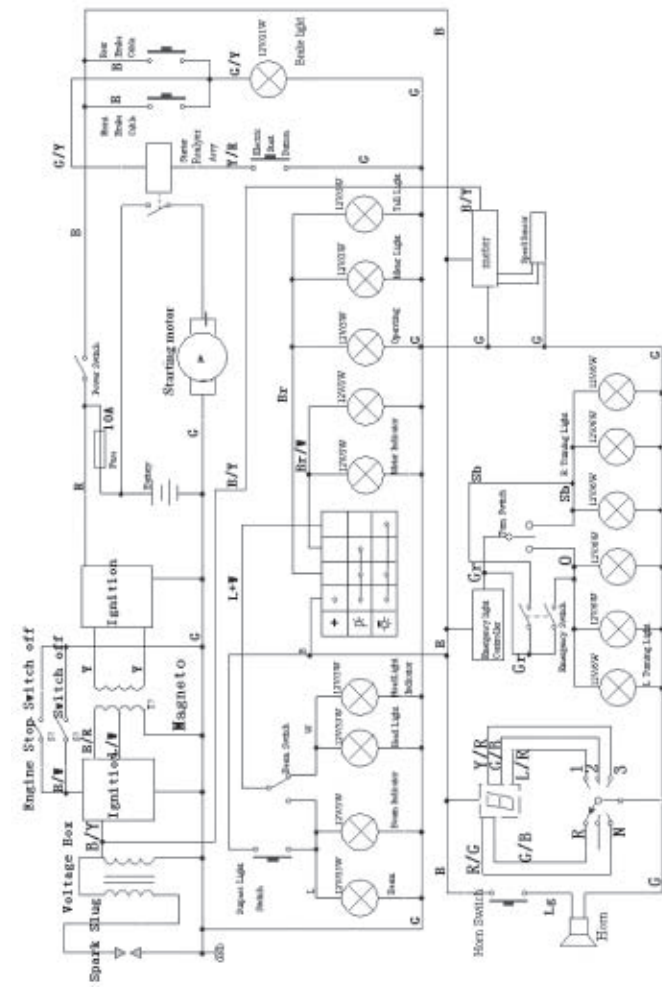
**Circuit Diagram**



## Specification

MODEL(S)	ATV Mini Blazer 110	ATV Mini Blazer 110	ATV Mini Blazer 110
Engine	152FMH	152FMH	152FMH
Compression	9.7:1	9.7:1	9.7:1
Ignition	CDI	CDI	CDI
Max Power(kw/r/rim)	5.1; 8000(1 ± 5%)	5.1; 8000(1 ± 5%)	5.1; 8000(1 ± 5%)
Max.Torque(N.m/r/min)	7.3; 6000(1 ± 5%)	7.3; 6000(1 ± 5%)	7.3; 6000(1 ± 5%)
Max .Loading	60kg	60kg	60kg
Transmission	chain	chain	chain
Max Speed	40 ± 5km/h	40 ± 5km/h	40 ± 5km/h
Fuel Tank	2.2L	2.2L	2.2L
Ground Clearance	70mm	70mm	70mm
LxW	1150 x 820mm	1150 x 820mm	1150 x 820mm
Seat Hight	660mm	660mm	660mm
Front Tire	145/70-6	145/70-6	145/70-6
Rear Tire	145/70-6	145/70-6	145/70-6
N.W / G.W	90KG/100KG	90KG/100KG	90KG/100KG
Packing Size	1120 x 660 x 640cm	1120 x 660 x 640cm	1120 x 660 x 640cm
Loading Quantity 1x40HQ	144	144	144

## Specification

MODEL(S)	ATV Mini Blazer 110	ATV Blazer 110	ATV Blazer 110
Engine	152FMH	152FMH	152FMH
Compression	9.7:1	9.7:1	9.7:1
Ignition	CDI	CDI	CDI
Max Power(kw/r/rim)	5.1; 8000(1 ± 5%)	5.1; 8000(1 ± 5%)	5.1; 8000(1 ± 5%)
Max.Torque(N.m/r/min)	7.3; 6000(1 ± 5%)	7.3; 6000(1 ± 5%)	7.3; 6000(1 ± 5%)
Max .Loading	60kg	75kg	75kg
Transmission	chain	chain	chain
Max Speed	40 ± 5km/h	45 ± 5km/h	45 ± 5km/h
Fuel Tank	2.2L	2.2L	2.2L
Ground Clearance	70mm	105mm	105mm
LxW	1150 x 820mm	1370 x 960mm	1370 x 960mm
Seat Hight	660mm	760mm	760
Front Tire	145/70-6	16 x 8-7	16 x 8-7
Rear Tire	145/70-6	16 x 8-7	16 x 8-7
N.W / G.W	90KG/100KG	95KG/105KG	95KG/105KG
Packing Size	1120 x 660 x 640cm	1200 x 760 x 640cm	1200 x 760 x 640cm
Loading Quantity 1x40HQ	144	112	112

## Specification

MODEL(S)	ATV Blazer 125U	ATV Blazer 125U	ATV Blazer 125
Engine	154FMI	154FMI	154FMI
Compression	9.3:1	9.3:1	9.3:1
Ignition	CDI	CDI	CDI
Max Power(kw/r/rim)	6.1; 8000(1 ± 5%)	6.1; 8000(1 ± 5%)	6.1; 8000(1 ± 5%)
Max.Torque(N.m/r/min)	8.6; 6000(1 ± 5%)	8.6; 6000(1 ± 5%)	8.6; 6000(1 ± 5%)
Max .Loading	75kg	75kg	75kg
Transmission	chain	chain	chain
Max Speed	60 ± 5km/h	60 ± 5km/h	60 ± 5km/h
Fuel Tank	2.2L	2.2L	4.3L
Ground Clearance	130mm	130mm	130mm
LxW	1450 x 1000mm	1450 x 1000mm	1520 x 1050mm
Seat Hight	780mm	780mm	760mm
Front Tire	19 x 7.00-8	19 x 7.00-8	19 x 7.00-8
Rear Tire	18 x 9.50-8	18 x 9.50-8	18 x 9.50-8
N.W / G.W	100KG/115KG	100KG/115KG	110KG/120KG
Packing Size	1200 x 760 x 640cm	1200 x 760 x 640cm	1270 x 830 x 640cm
Loading Quantity 1x40HQ	112	112	92

